

**KER340UL/EMCYR****Katko Rustfri/EMC Rep.afbr. 3P 40A**

UL-godkendt, rustfrit stål 2xM25

Leverandør: Katko

<https://www.katko.com/>**Teknisk data**

|  |               |
|--|---------------|
| Antal poler                              | 3             |
| Nominel permanent strøm ved AC-21, 400 V | 63A           |
| Nominel permanent strøm ved AC-23, 400 V | 40A           |
| Nominel drifteffekt på AC-23, 400V       | 22kW          |
| Kapslingstype                            | RA2           |
| Kapslings materiale                      | Rustfrit stål |
| Beskyttelsesklasse (IP) forside          | IP66          |

**Logistik data**

|            |               |
|------------|---------------|
| Nettovægt  | 1,3 kg        |
| Bredde     | 120 mm        |
| Højde      | 160 mm        |
| Dybde      | 115 mm        |
| Landekode  | FI            |
| Toldnummer | 85365080      |
| EAN        | 6419410309322 |



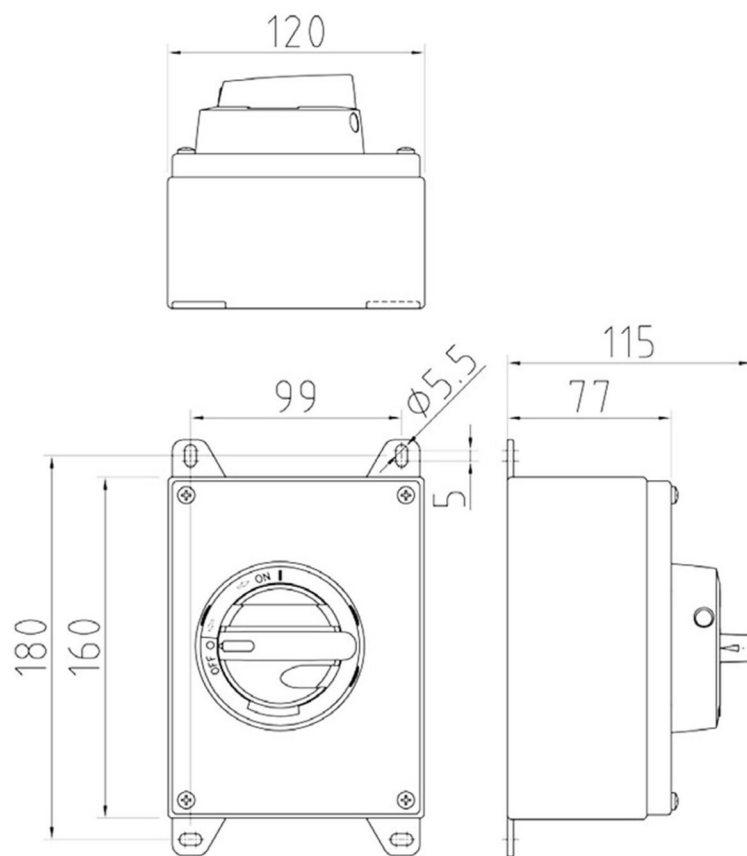

**RA2**